

EH-VS Trick-Track

LED Linear Trunking system

LED |



Installation Instructions

Technical data:

- Input: 220-240Vac 50-60Hz.
- IP54
- Electrical protection class: Class I

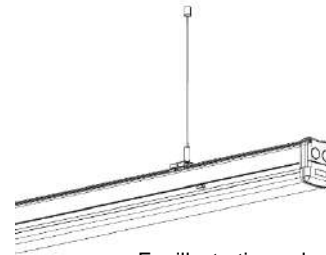

For illustration only

Disconnect mains power before installation.

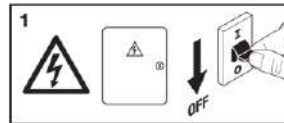

Important:

This light fixture is classified as electrical & electronic waste (WEEE). Once ceased operation It is mandatory to destroy it according to your local waste directives.

Warning:

1. Connecting this light fixture to mains will be conducted only by qualified and licensed electrician. It is mandatory to disconnect mains supply prior to installation or service.
2. Replace any broken protective cover.
3. This light fixture is designed for indoor installation, according to listed IP level.
4. The usage of non-complying dimming devices for low voltage systems may damage the power supply device.
5. The light fixture must not be covered by any isolation material.

Maintenance:

1. Use only a soft antistatic wipe to clean the diffuser.
2. In case of a fault, do not try to fix it on your own. Uninstall the light fixture and contact your nearest official service station.
3. To not use Alcohol, detergents, chemical and such to clean the light fixture.
4. The light unit source is non-replaceable.

Electrical wiring scheme:





Installation instructions:

1. Suspension mounting

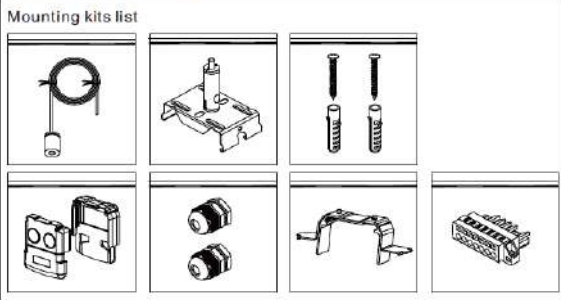

Tools

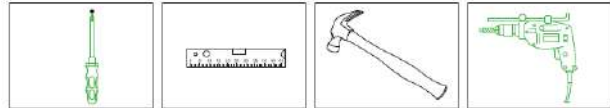

Suspension mounting

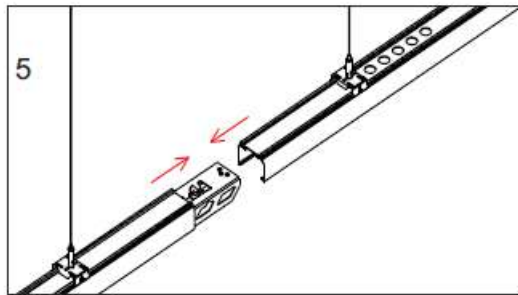
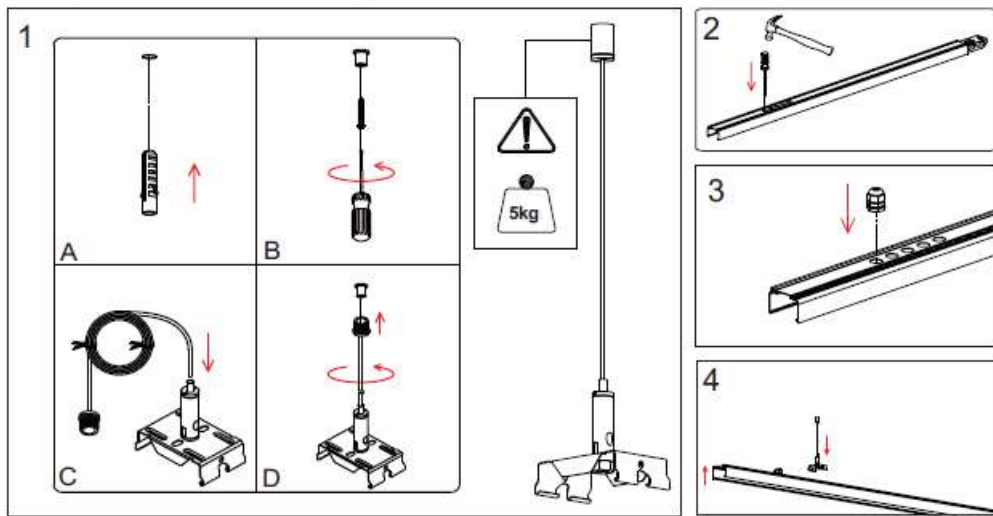

2. Connect power-supply wires.

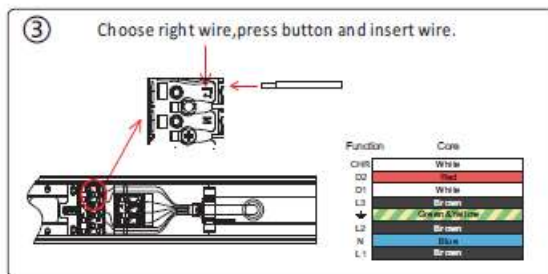
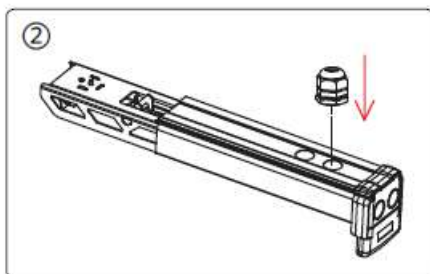
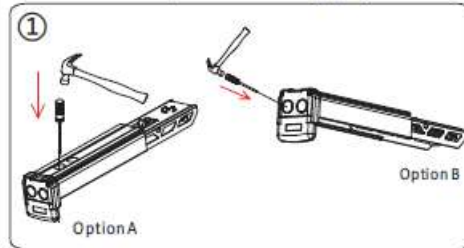

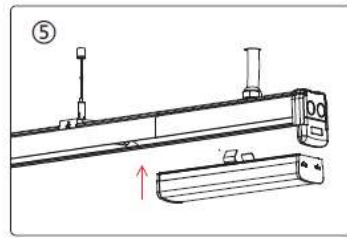
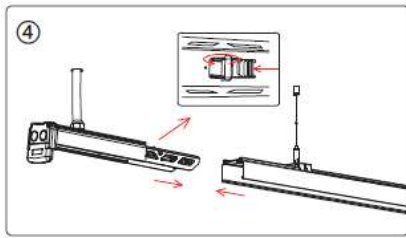

3. Connect trunks

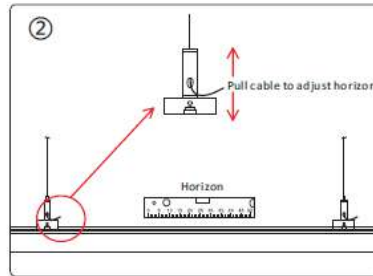
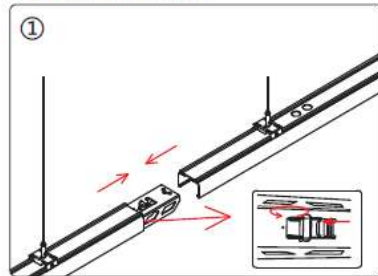

4. Ended with end box on last trunk.

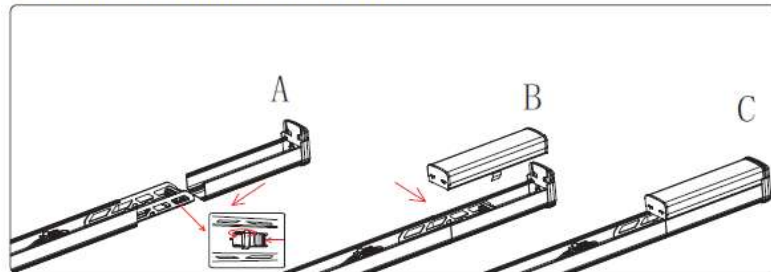

5. Switch right phase and insert modules.

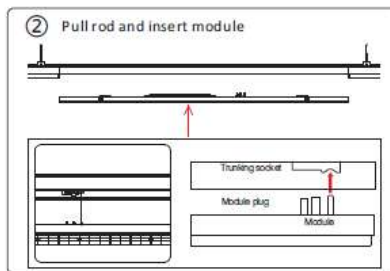
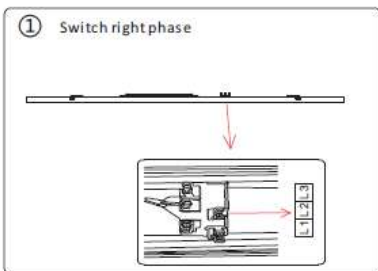
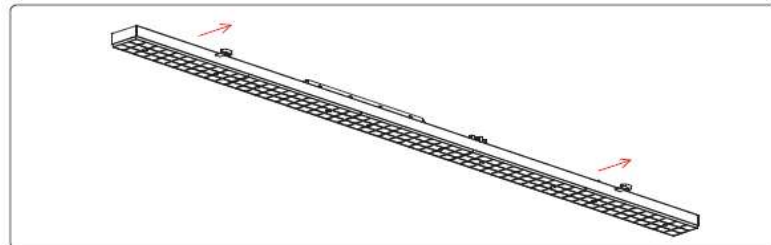

6

